

DC56B



Specifications

Dimension:	113mm*83mm*99mm
Weight:	0.48kg
Inlet (Outer diameter):	20mm
Outlet (Outer diameter):	20mm
Material of pump shell:	PPS & PA66+30%GF (can be customized to other materials)
Max working temperature:	-30°C-100°C
Noise class:	<35dB

Sub-model List

Model	Rated voltage	Working voltage	Rate current	Max flow rate	Max static head
DC56B-12100S	12V DC	10-18V	4.5A	2100L/H	10M
DC56B-12100VR					
DC56B-12100PWM					
DC56B-18140S	18V DC	10-24V	4.5A	2700L/H	14M
DC56B-18140VR					
DC56B-18140PWM					
DC56B-24140S	24V DC	10-30V	3.3A	2700L/H	14M
DC56B-24140VR					
DC56B-24140PWM					
DC56B-36140S	36V DC	15-40V	2.2A	2700L/H	14M
DC56B-36140VR					
DC56B-36140PWM					

The sub-model list is for reference only, parameters can be customized according to requirements.

[Click to check the model code instruction.](#)

[Click to view our customized services.](#)

Dimensions

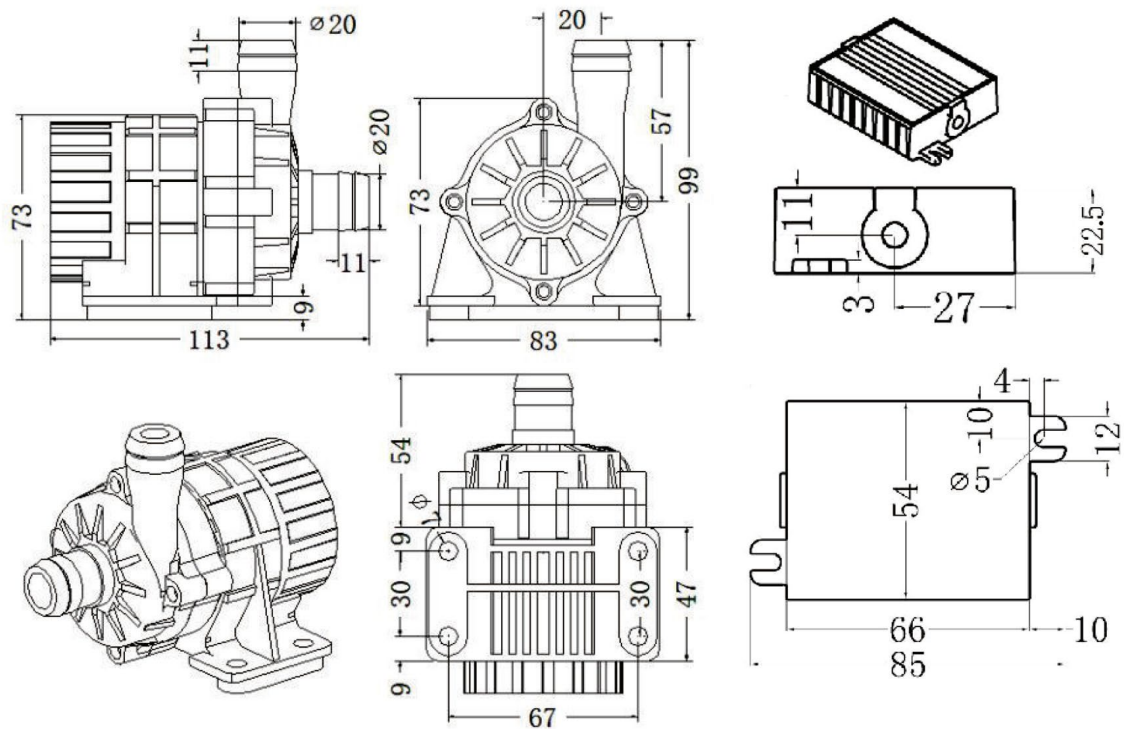

Performance

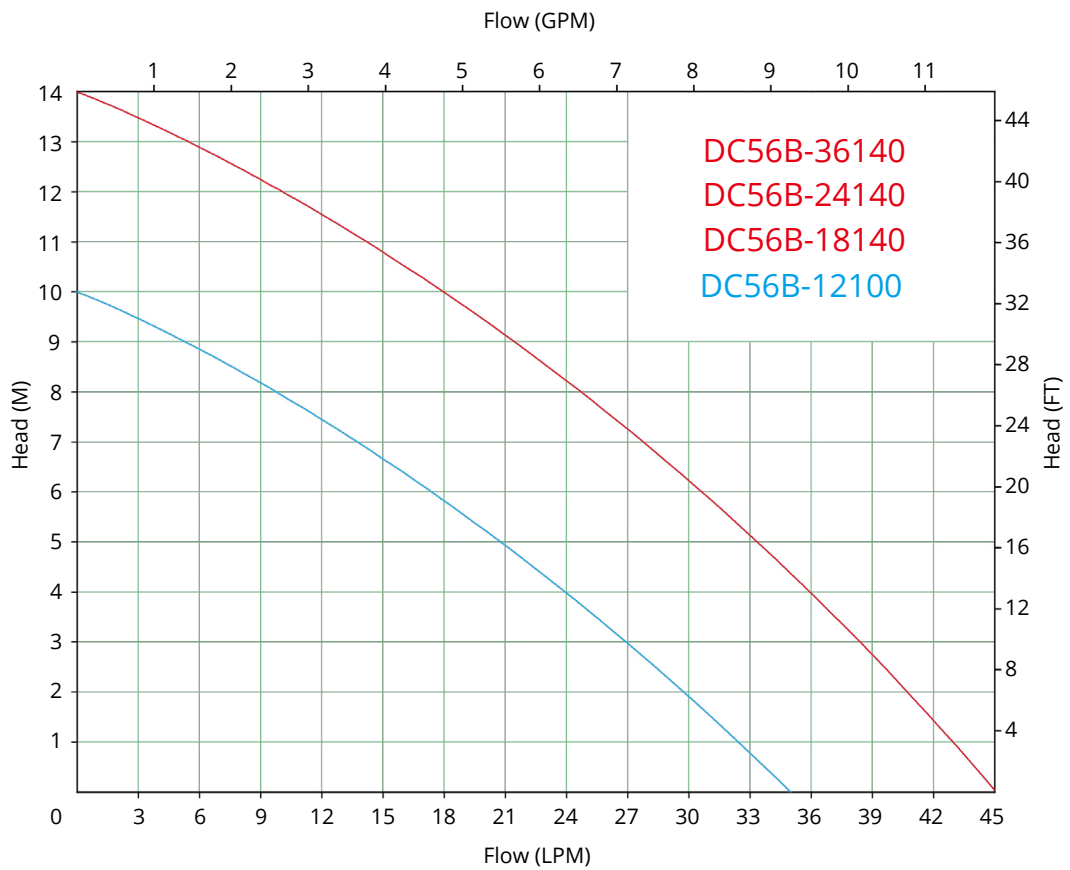

PRODUCT FEATURES

Efficiency and Durability

Features: Brushless DC motor (EC motor), magnetic separation drive, long-term continuous operation, lifespan of about 30,000 hours, low energy consumption and high efficiency, free maintenance.

Safety and Environmental Protection

Low voltage operation, no sparks, explosion-proof, magnetic isolation pump will not leak, waterproof grade up to IP68.

Multi-function and Intelligent Control

Built-in electronic control can add various functions, such as dry running and jam protection, over-voltage, under-voltage protection, etc. All pump parameters can be customized according to customer requirements.

Wide Applications and Applicable Media

Can be used to pump water, oil, acid and alkali solutions (special liquids require testing), applicable to a wide range of environments, including continuous working diving or land use (not self-priming).

Quality Materials and Design

Ceramic shaft with carbon fiber graphite sleeve, as well as PTFE-graphite and SiC sleeve, small size design but large flow and high pressure.

Silent

Low noise, ensuring a silent effect while achieving efficient energy utilization.

PRODUCT EXPLODED VIEW

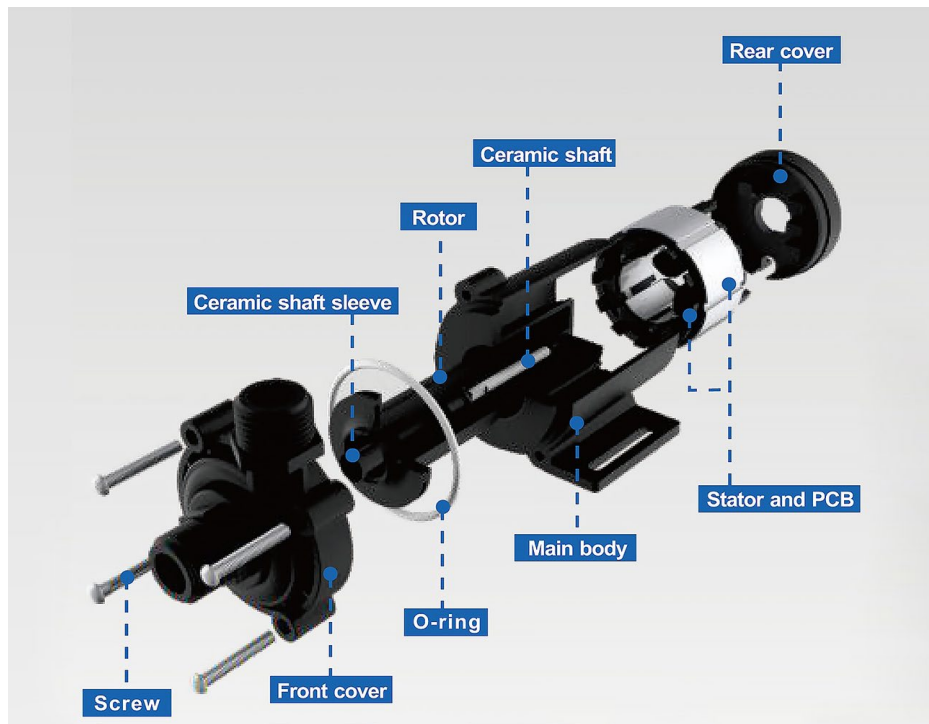

INSTALLATION

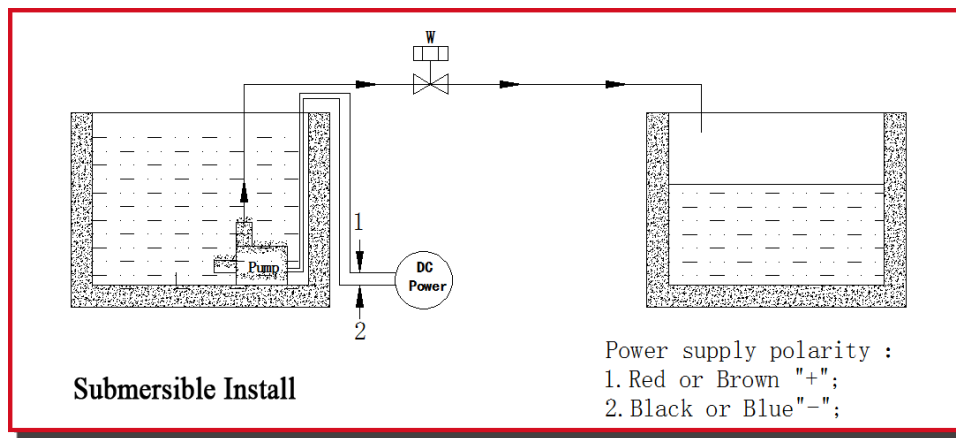
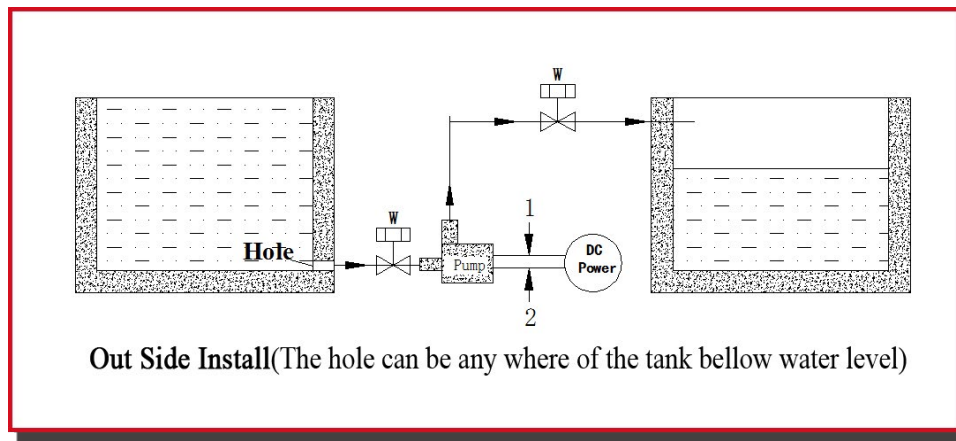

Power supply polarity :
 1. Red or Brown "+";
 2. Black or Blue "-";

WIRING INSTRUCTIONS

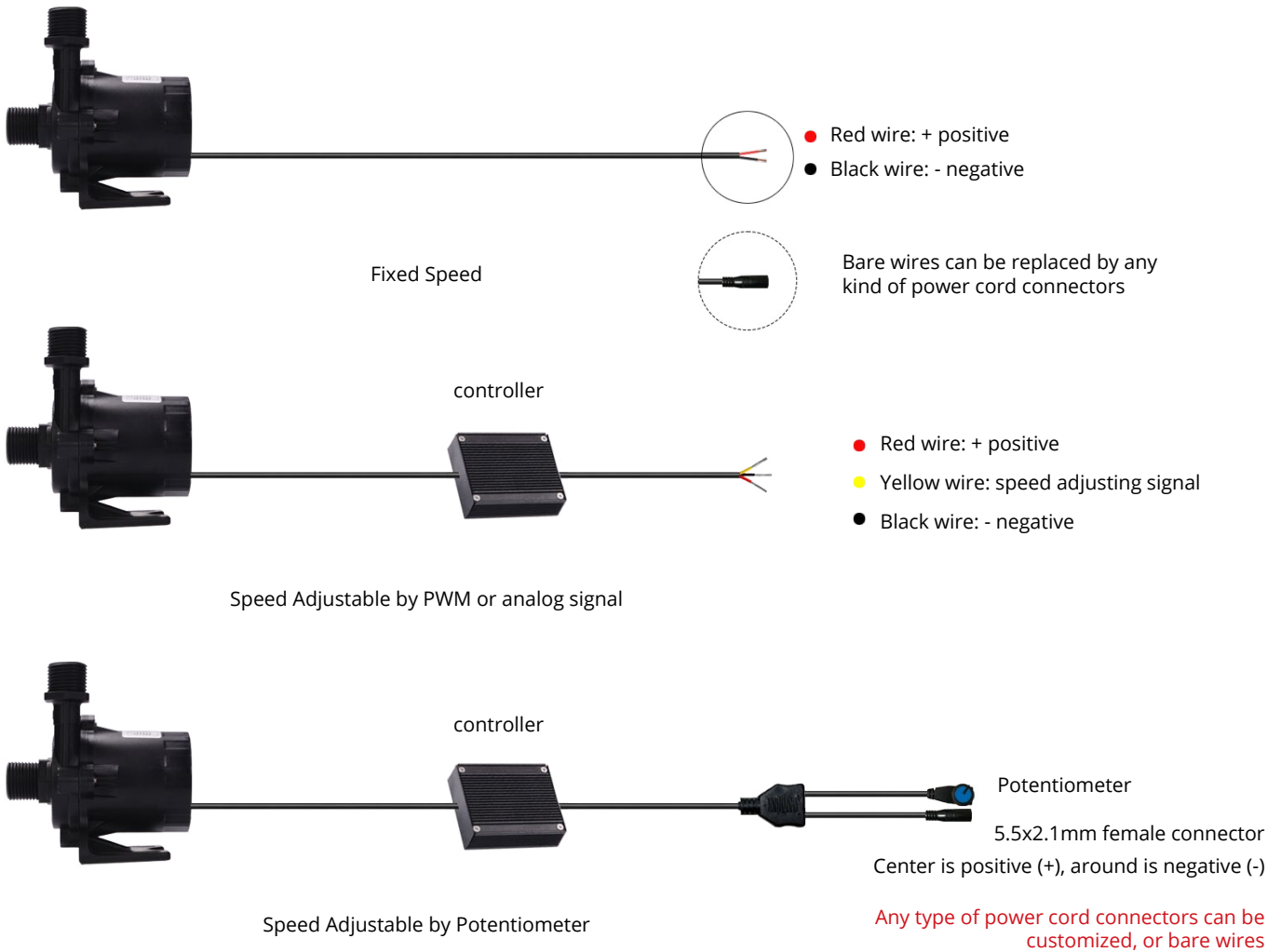

A speed feedback wire can be added to any series of BLDC Pumps.

The built-in controller is suitable for application scenarios with small power pumps and good ambient heat dissipation conditions. The external controller is suitable for large power pumps and application scenarios with poor environmental heat dissipation conditions.

Consult us to learn more: sales@bldcpump.com

PUMP MODEL CODE INSTRUCTION

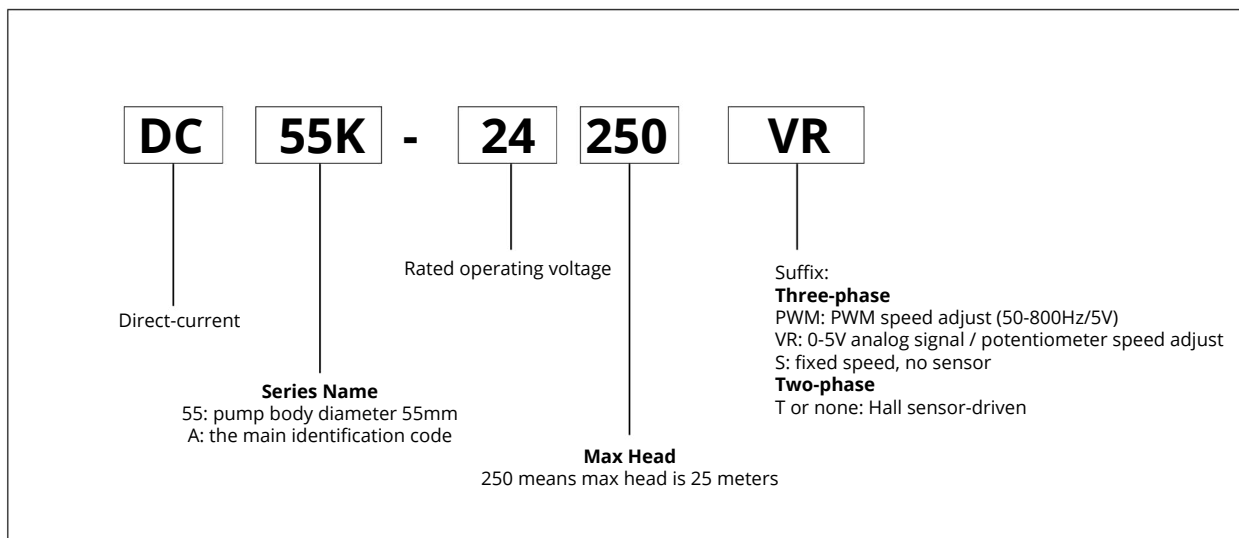

ADDITIONALL FUNCTIONS INSTRODUCTION

Function	Trigger	Phenomenon	Reset
Dry-run Protection	Not enough fluid or some air could not be pushed out from the pump	The water pump runs intermittently (3 seconds), cyclically	Automatically reset when the fluid is full
Stuck Protection	When impeller is stuck	The water pump runs intermittently (3 seconds), cyclically	Automatically reset when the impeller can rotate normally
Over-voltage Protection	When the input voltage is higher than its working voltage range	Pump stop working	When the input voltage returns to its working voltage range
Low-voltage Protection	When the input voltage is less than its working voltage range	Pump stop working	When the input voltage returns to its working voltage range

Additional pump functions is optional and need to consult with us. All the parameters can be customized such as over-voltage protection volt, low-voltage protection volt, the time of intermittent operation, etc.

The functions above are only for example. If you need further functions, please contact us immediately: sales@bldcpump.com.

Understanding Our Pump Variants

Two-phase vs. Three-phase

You can determine whether a pump is two-phase or three-phase by the suffix in the complete [pump model code](#). Most of the time, you only need to focus on whether the pump meets your application requirements, without worrying about whether it is two-phase or three-phase. The table below lists some differences between two-phase and three-phase pumps.

	Driver Type	Maximum Operating Temperature	Noise Level	Speed Adjusting	Implus voltage	Constant Power
Two-phase	Driven by a Hall sensor (the controller must be placed inside the pump)	60°C	<40db	- 0-5V analog signal - Potentiometer	68V (rated voltage 24V)	No
Three-phase	No Hall sensor required, software-driven, with the controller being either built-in or external.	60°C (Built-in controller) 100°C (external controller)	<35db <30db (sine wave)	- 0-5V analog signal - Potentiometer - PWM 5V 50-800Hz (can be customized)	27V (rated voltage 24V)	The sine wave version supports constant power operation. For a pump rated at 24V, it offers a constant power output between 24-30V, and for a pump rated at 12V, it provides constant power output between 12-24V.

Built-in vs. External Controller

The external controller is designed to enable the pump to accommodate higher environmental or medium temperatures. Only three-phase pumps have the capability for an external controller placement.

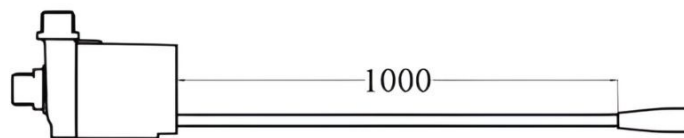

Built-in Controller: Suitable for low-temperature media or environments.

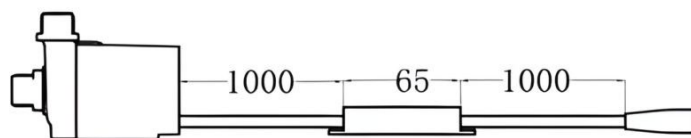

External Controller: Suitable for high-temperature media or environments.

BLDC PUMP Selection Guide

Choosing the right pump for your application is crucial for achieving optimal performance and efficiency. This guide simplifies the process, ensuring you select the perfect pump to meet your specific needs.

1. Understand Your Requirements

Flow Rate & Head: Determine the desired flow rate (LPH or GPH) and head height (meters or feet) your application requires. These are critical for ensuring the pump meets your system's demands.

Operation Environment: Consider the liquid type (water, oil, acid/alkali solutions), temperature range, and whether the pump will be exposed to harsh chemicals.

Electrical Requirements: Identify the voltage and wattage your system can supply to ensure compatibility with the pump's electrical requirements.

Continuous Operation: Assess if the pump needs to operate continuously and ensure it is designed for long-term use without overheating.

2. Choose the Right Model

Review our product catalog to identify pumps that match your flow rate, head height, and operational environment needs. Remember, BLDC pumps are known for their efficiency, compact design, and reliability in various applications, from automotive cooling systems to aquarium setups.

3. Consider Customization Options

Wire Length & Plug Type: Customize the power wire length and plug type to suit your installation requirements.

Pump Appearance: Utilize our mold factory for quick development of custom dimensions and inlet/outlet orientations.

Material Adaptation: Select materials compatible with your specific liquid type, ensuring longevity and reliability.

Labeling & Packaging: Enhance your brand with custom labels and packaging options.

Voltage & Wattage: Specify the operational voltage and wattage for seamless integration into your system.

Control Program Development: Collaborate with our engineers to develop a unique control program, enhancing functionality and integration with your system.

4. Additional Features and Protection

- Evaluate pumps with built-in protection features such as dry run, overload, and thermal protection for increased durability and safety.
- Consider pumps with adjustable flow rates and the ability to operate in submersible or external configurations, depending on your application.

5. Consult with Experts

If uncertain, reach out to our skilled technicians for advice. We can guide you through selecting the perfect pump, considering your unique requirements and offering solutions tailored to your application.

Making Your Choice

Selecting the right water pump is more than just matching specifications. It's about understanding your system's unique demands and finding a pump that can meet those needs efficiently and reliably. With BLDC PUMP's expertise and wide range of customizable options, you're sure to find a solution that not only fits but enhances your application.